

NP-6135

- Desktop High Performance CPU
- Control cabinet Industrial PC

■ Features

- Support Intel® Core™ 10th/11th generation i9/i7/i5/i3 high performance processors, Max. TDP 65W
- 2 x Intel GbE LAN controller
- 4 x USB3.0, USB2.0 Type A on board for dongle
- 2 x RS232/RS485, RS485 support auto flow control
- Support both VGA and HDMI display port
- 1 x miniPCIe expansion slot, Support Wifi,3G/4G modules
- DC12~24V Power supply with overcurrent, overvoltage and polarity inverse protection
- Support wall-mounted or DIN-Rail fixing style
- Wide operating temperature -20 ~ 60°C supported



■ Specifications

Model Name		NP-6135	
System	CPU	Intel® Core™ 10th/11th gen i9/i7/i5/i3 LGA1200 type CPU	
	TDP	Max. 65W	
	BIOS	AMI UEFI 64Mbit	
	Memory	2 x SO-DIMM DDR4, max up to 32GB	
	Storage		1 x mSATA bay
			1 x M.2(B Key, Type 2280) bay support SATA
	USB	4 x USB3.0, 1 x USB2.0 Type A on the board for USB dongle	
	COM	2 x COM(DB-9), selectable to support RS232 or RS485 mode by the switch, RS485 support auto flow control, (ESD protection for RS232: Air gap ±8KV, Contact ±6KV)	
	Ethernet	2 x Intel GbE LAN controller	
	VGA	Support up to 1920 x 1080 @60Hz	
	HDMI	Support up to 3840 x 2160 @60Hz	
	Expansions	1 x Full-size PCIe Mini slot with SIM card holder(with USB signal)	
	Watch Dog	1~255 levels programmable	
OS Support	Microsoft Windows	Windows 10	
	Linux	Ubuntu, CentOS, Debian	
Power	Voltage Input	DC12~24V ±10%, overcurrent, overvoltage and polarity inverse protection	
	Power Consumption	Max. 120W	
Chassis	Structure	Aluminum-magnesium alloy BOX with fan embedded to assist cooling, Wall-mounted or DIN-Rail fixing style.	
	Dimensions	(L)200mm x (W)154.5mm x (H)57.6mm	
	Net Weight	1.9Kg	
Environment	Work Temperature	-20°C ~ 60°C (-4°F~140°F) with air flow (SSD)	
	Storage Temperature	-40°C ~ 80°C (-40°F ~ 176°F) with air flow (SSD)	
	Relative Humidity	5~95% (Non-condensing)	
	Operating Vibration	5~500Hz, 1.5Grms@with SSD, Follow IEC60068-2-64	
	Operating Shock	20G peak acceleration(11ms duration) with SSD, Follow IEC60068-2-27	
	EMC	CE/FCC Class A	

■ Dimensions (Unit: mm)

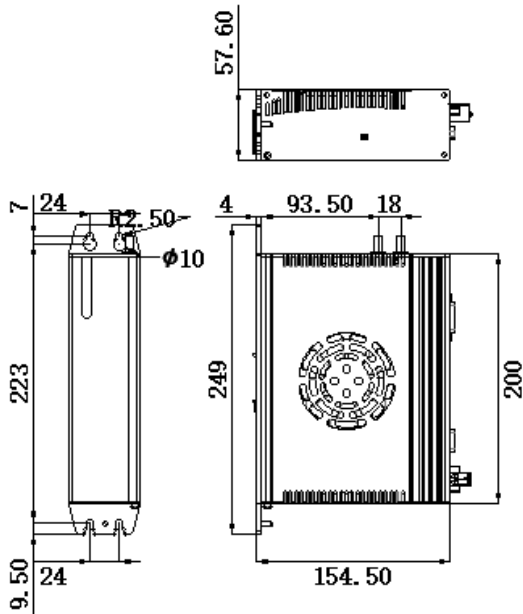

■ Interfaces

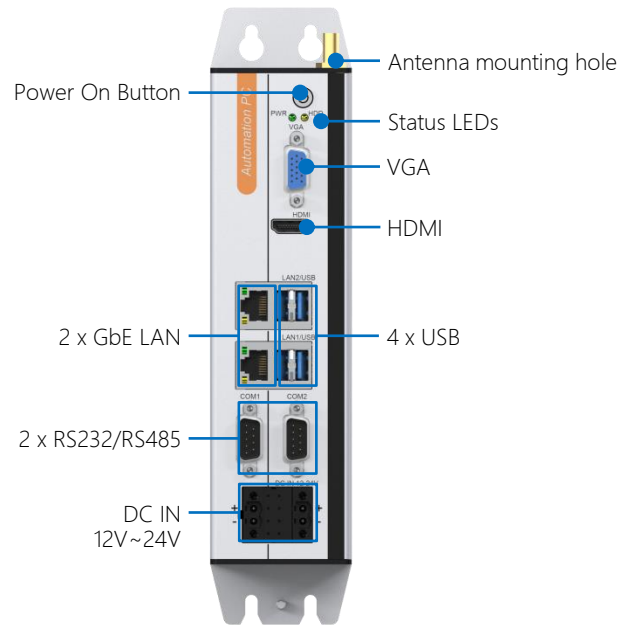

■ Ordering Information

Part No.	Product	Description
6070200236	NP-6135	CPU:NULL, RAM:NULL, mSATA:NULL, M.2 SATA: NULL, 2 x RS232/485(Selectable), 2 x LAN, 4 x USB3.0, VGA/HDMI display port, DC12~24V Power input

■ Options

Parts	Description
CPU	Intel® Core™ Comet lake i3-10100T, i3-10100, i3-10105T, i3-10105, i5-10400T, i5-10400, i5-10500
	Intel® Core™ Rocket lake i5-11400T, i5-11500T, i5-11600T, i5-11400, i5-11500, i5-11600
DDR4 Memory	4GB, 8GB, 16GB
mSATA SSD	64GB, 128GB, 256GB, 512GB, 1TB
M.2 SATA SSD	128GB, 256GB, 512GB, 1TB, 2TB
Wifi Set	miniPCIE WIFI Set (7260 series) ,Cylindrical antenna
3G/4G Module	mini PCIE, EC20, EG25, EC25
Mount Option	DIN-Rail

Note: If some optional parts are offered with the system, additional system certificates may be required in certain regions/countries. Please contact NODKA for certificate compliance.